



Exklusiv von HADEF
Exclusiv from HADEF
Exclusivité HADEF

ALU

Klein, kompakt, leicht
Small, light weight, easy handling
Compact et léger

- 

bis zu 45 % leichter im Vergleich zu Standardgeräten dieser Tragfähigkeitsreihe
Up to 45 % less weight compared with standard hoists
Jusqu'à 45 % plus léger
- 

Verstärkte Hakensicherung für Aufhänge- und Lasthaken
Reinforced safety catch for suspension and load hook
Linguet de sécurité renforcé pour crochet de suspension et de charge
- 

Weitgehend geschlossenes Aluminiumgehäuse
Mostly enclosed aluminium body
Carter fermé en aluminium
- 

Ketteneinlaufhilfe garantiert den sicheren, geführten Einlauf der Kette in das Gerät
Chain guide device ensures safe and guided feed-in of the chain
Entrée de chaîne optimisée garantie un enroulement sûr et guidé de la chaîne
- 

Optional mit Kettenspeicher.
Auch zum Transport des Kettenzuges geeignet.
Optional with chain container.
Easy to use as transport bag.
Optionalement avec sac à chaîne.
Utilisation pratique pour transporter le palan.

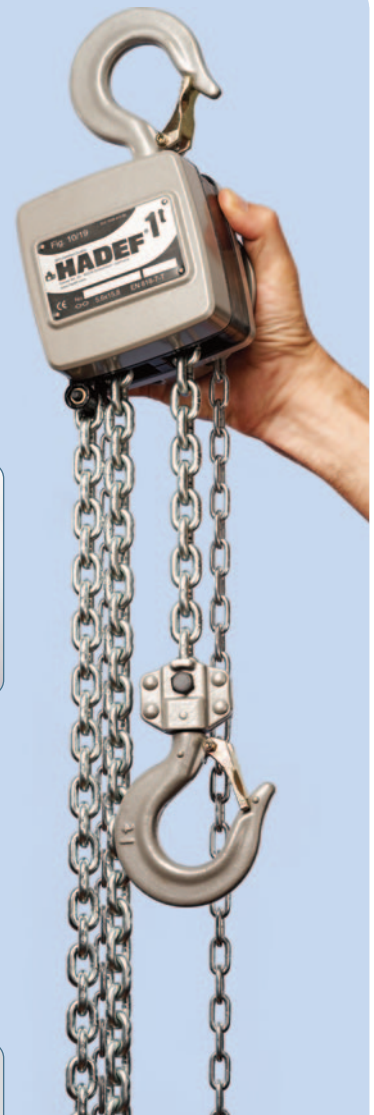
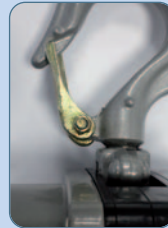



ALU

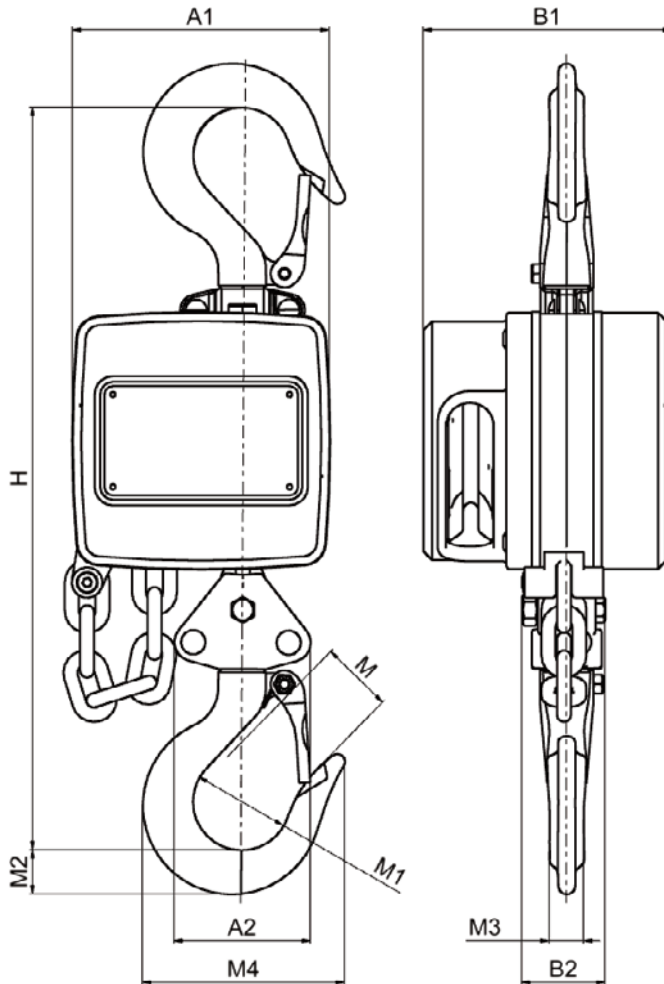

Tragfähigkeit/Kettenstränge Capacity/Chain falls Capacité/Brins de chaîne	Hauptabmessungen in mm Main dimensions in mm Dimensions principales en mm										
	A1	A2	B1	B2	M	M1	M2	M3	M4	H	
	kg										
	250 / 1	75	30	77	26	20	31	14	11	65	225
500 / 1	92	49	89	29	21	33	17	11	72	265	
1000 / 1	110	51	102	35	26	41	24	15	94	295	
1500 / 1	130	64	120	37	30	41	30	20	104	350	
2000 / 1	145	64	138	43	34	44	33	22	119	390	
3000 / 2	165	85	120	47	35	47	35	25	126	470	
5000 / 2	170	113	160	65	42	66	47	22	159	580	

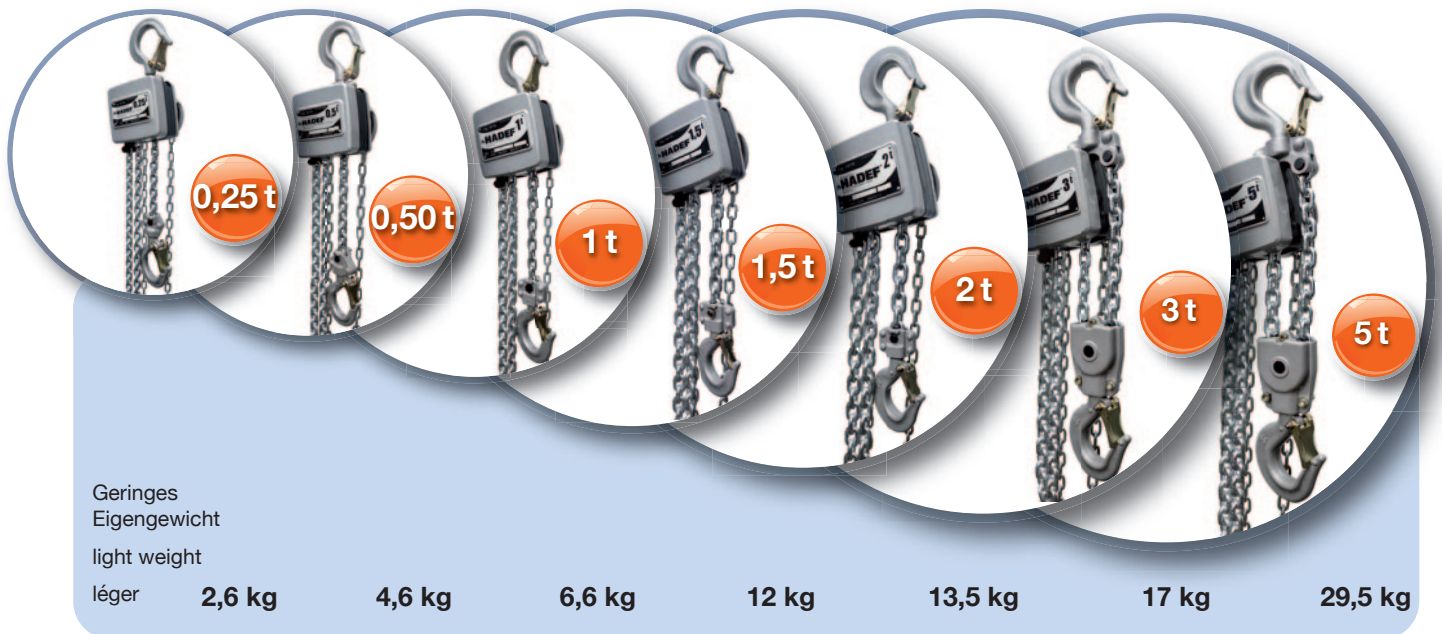

Tragfähigkeit/ Kettenstränge	Lastkette	Handkette	Hub nach 30 m Handkette	Handkraft bei Nennlast	Gewicht Weight Poids	
	Load chain	Hand chain	Lift at 30 m hand chain	Hand chain pull	bei 3 m Aufhängehöhe at 3 m suspension height	je m Mehrhub per add. m lift
	Chaîne de charge	Chaîne de manœuvre	Levage par déroulement de 30 m chaîne de manœuvre	Effort à la chaîne de manœuvre	pour 3 m de hauteur de suspension	par m add. de levage
kg	mm	mm	mm	N	ca./approx./env. kg	ca./approx./env. kg
250 / 1	3 x 9	2,5 x 12	1202	147	2,6	0,4
500 / 1	4,2 x 12,2	3,5 x 16	758	187	4,6	0,8
1000 / 1	5,6 x 15,8	3,5 x 16	489	280	6,6	1,1
1500 / 1	7,1 x 20,1	4,8 x 22	420	320	12	1,5
2000 / 1	8 x 24	4,8 x 22	332	360	13,5	1,8
3000 / 2	7,1 x 20,1	4,8 x 22	210	340	17	3,1
5000 / 2	9 x 27	4,8 x 22	313	365	29,5	4,7



HADEF

ALU

ISO 9001
certified company

PROFESSIONAL LINE

Das Aluminium Produktprogramm The Aluminium product range La gamme aluminium

ALU

Klein, kompakt, leicht
Small, light weight, easy handling
Compact et léger



**DER
KRAFT-
ZWERG®**



Ratschzug/ Ratchet Lever Hoist/
Palan à levier

53/07 A
250 - 3000 kg



Aluminium-Seilwinden/
Aluminium Wirerope Winches/
Treuils manuel aluminium

199/75
63 - 250 kg

200/77
50 - 100 kg



Aluminium-Portalkran/
Aluminium Gantry Crane/
Portique en aluminium

700
750 - 3000 kg

Aluminium-Dreibock /
Aluminium- Tripod /
Trépied Aluminium

1000 kg



Seilzug/ Wirerope Pull Hoist/
Treuil à câble passant en Aluminium

147/05
800 - 5400 kg